

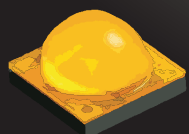

CO.SI.ME.

EQUIPMENT FOR ATEX

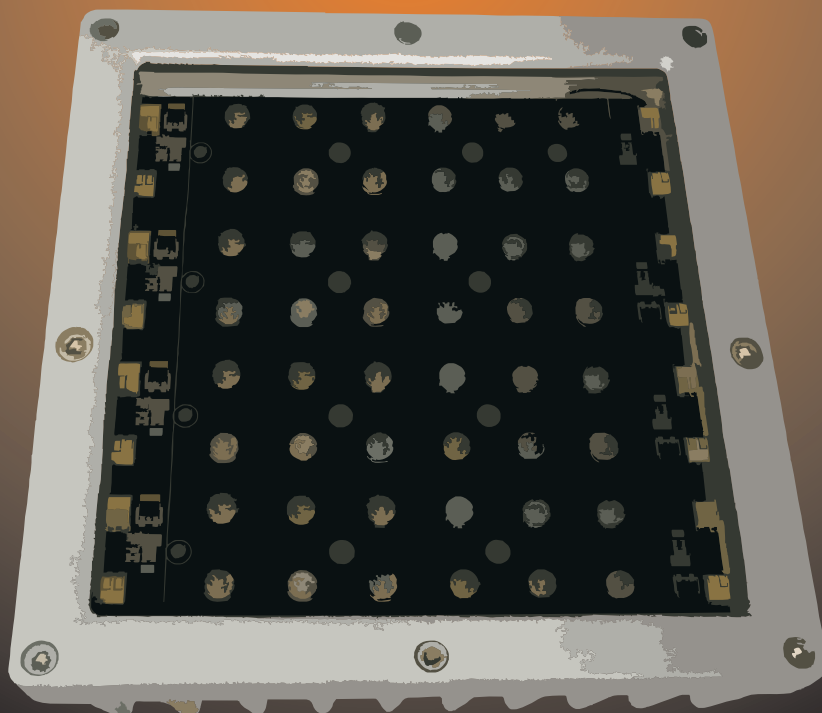

CREE



 **CO.SI.ME.srl**
EQUIPMENT FOR ATEX

APPARECCHI DI ILLUMINAZIONE A LED
LED LIGHTING EQUIPMENT



GAS	II2G Ex emb IIC T5 ÷ T4	Gb	IP66	Zone 1 - Zone 21 - Zone 2 - Zone 22	
DUST	II2D Ex mb IIIC T95°C ÷ T130°C	Db	IP66	❄️-20°C ÷ ☀️+40°C	❄️-20°C ÷ ☀️+60°C

Materiale : corpo : lega leggera
trasparente : vetro temperato con elevato rischio di impatto meccanico : 4 joule

Installazione : universale con staffa in acciaio inox AISI 304

Viteria : Acciaio inox AISI 304

Guarnizioni : Silicone

Collegamento : Morsettiera : 2.5mm²

Ingresso : N° 1 pressacavo M20x1.5

Material : *body : light alloy*
transparent : tempere high impact resistant
glass : 4 joule

Installation : *universal with stainless steel AISI 304 bracket*

Hardware : *Stainless steel AISI 304*

Gaskets : *Silicon*

Connection : *Terminals mm²*
2x1,5 mm²

Cable entry : *N° 1 cable gland M20x1.5*

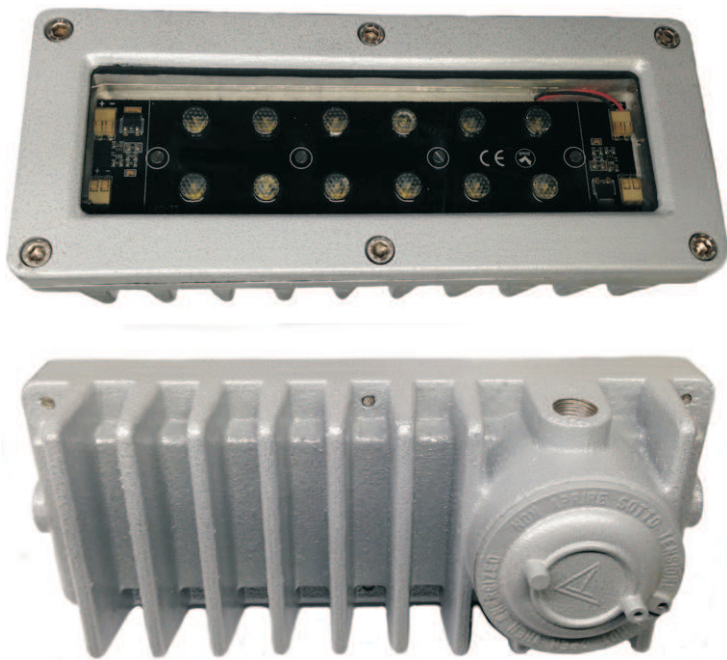

Potenza : Vedi tabella

Tensione : 230Vac (altre tensioni a richiesta)

Corrente : 0,85+3,4A

Frequenza : 50Hz + 60Hz

Indice colore : 80

Durata : >50.000 ore

Power : See table

Voltage : 230Vac (other voltage on demand)

Frequency : 50Hz + 60Hz

Color index : 80

Life time : >50.000 ore

Sistema lenti FRAEN secondarie
FRAEN Secondary lens system



Codice Code	[W]	N° led Led N°	Fusso [lm] Flux [lm]	colore [k] color [k]	Irragg. Radiance	Lente Lens	Tensione [V] Voltage [V]	Peso[kg] Weight [kg]
PRO 12EX230AC	20	12	2600	5000	115°	-	230Vac	2,5
PRO 12EX230AC44	20	12	2600	5000	-	44°	230Vac	2,7
PRO 12EX24DC	20	12	2600	5000	115°	-	24Vdc	2,5
PRO 12EX24DC44	20	12	2600	5000	-	44°	24Vdc	2,7

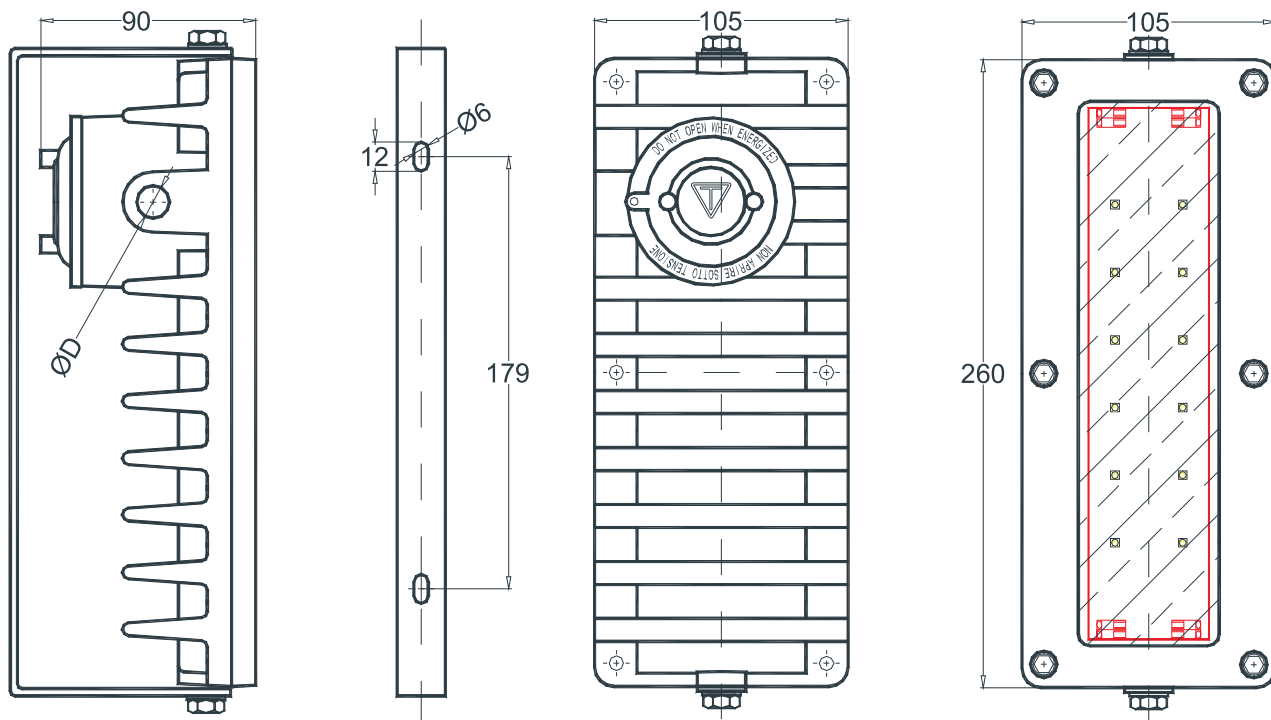

K1



GAS	II2G Ex emb IIC T5 ÷ T4	Gb	IP66	Zone 1 - Zone 21 - Zone 2 - Zone 22
DUST	II2D Ex mb IIIC T95°C ÷ T130°C	Db	IP66	☀-20°C ÷ ☀+40°C ☀-20°C ÷ ☀+60°C

Materiale: corpo: lega leggera
trasparente: vetro temperato con elevato rischio di impatto meccanico: 4 joule

Installazione: universale con staffa in acciaio inox AISI 304

Viteria: Acciaio inox AISI 304

Guarnizioni: Silicone

Collegamento: Morsetteria: 2.5mm²

Ingresso: N° 1 pressacavo M20x1.5

Material: body: light alloy
transparent: tempere high impact resistant glass 4 joule

Installation: universal with stainless steel AISI 304 bracket

Hardware: Stainless steel AISI 304

Gaskets: Silicon

Connection: Terminals mm² 2x1,5 mm²

Cable entry: N° 1 cable gland M20x1.5

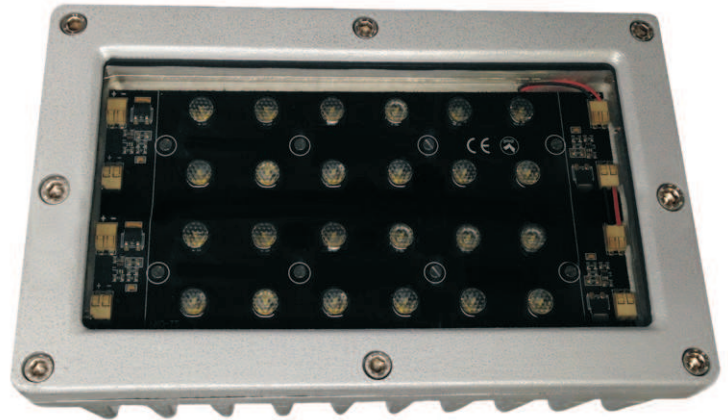

Potenza: Vedi tabella

Tensione: 230Vac (altre tensioni a richiesta)

Corrente: 0,85+3,4A

Frequenza: 50Hz + 60Hz

Indice colore: 80

Durata: >50.000 ore

Power: See table

Voltage: 230Vac (other voltage on demand)

Frequency: 50Hz + 60Hz

Color index: 80

Life time: >50.000 ore

Sistema lenti FRAEN secondarie
FRAEN Secondary lens system



KHATOD NACTUS compatibile
Compatible KHATOD NACTUS

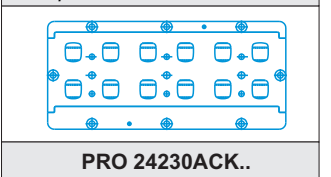

Codice Code	[W]	N° led Led N°	Fusso [lm] Flux [lm]	colore [K] color [K]	Irragg. Radiance	Lente Lens	Tensione [V] Voltage [V]	Peso[kg] Weight [kg]
PRO 24EX230AC	50	24	5200	5000	115°	-	230Vac	6,5
PRO 24EX230AC44	50	24	5200	5000	-	44°	230Vac	7,0
PRO 24EX230ACK..	50	24	5200	5000	-	KATHOD page Y5	230Vac	7,2
PRO 24EX230AC	50	24	5200	5000	115°	-	24Vdc	6,5
PRO 24EX230AC44	50	24	5200	5000	-	44°	24Vdc	7,0
PRO 24EX230ACK..	50	24	5200	5000	-	KATHOD page Y5	24Vdc	7,2

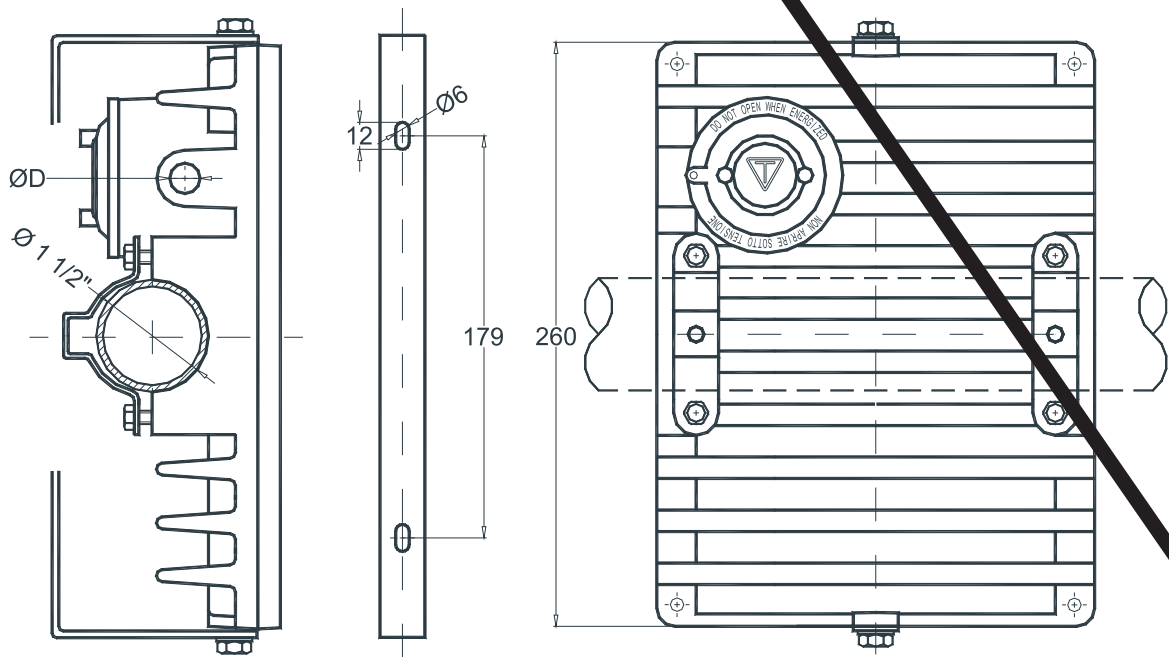



GAS	II2G Ex emb IIC T5 ÷ T4	Gb	IP66	Zone 1 - Zone 21 - Zone 2 - Zone 22	
DUST	II2D Ex mb IIIC T95°C ÷ T130°C	Db	IP66	❄️ -20°C ÷ ☀️ +40°C	❄️ -20°C ÷ ☀️ +60°C

Materiale : corpo : lega leggera
trasparente : vetro temperato con elevato rischio di impatto meccanico : 4 joule

Installazione : universale con staffa in acciaio inox AISI 304

Viteria : Acciaio inox AISI 304

Guarnizioni : Silicone

Collegamento : Morsettiera : 2.5mm²

Ingresso : N° 1 pressacavo M20x1.5

Material : *body : light alloy*
transparent : tempere high impact resistant glass : 4 joule

Installation : *universal with stainless steel AISI 304 bracket*

Hardware : *Stainless steel AISI 304*

Gaskets : *Silicon*

Connection : *Terminals mm²*
2x1,5 mm²

Cable entry : *N° 1 cable gland M20x1.5*

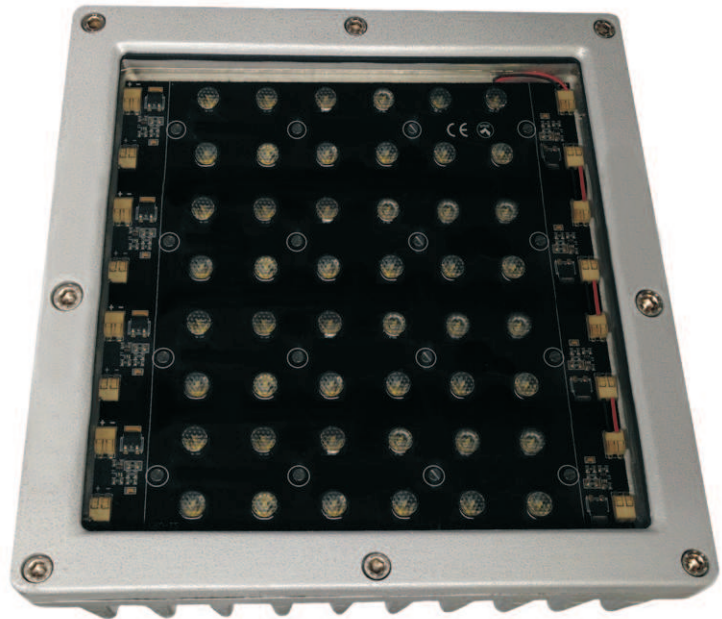

Potenza : Vedi tabella

Tensione : 230Vac (altre tensioni a richiesta)

Corrente : 0,85+3,4A

Frequenza : 50Hz + 60Hz

Indice colore : 80

Durata : >50.000 ore

Power : See table

Voltage : 230Vac (other voltage on demand)

Frequency : 50Hz + 60Hz

Color index : 80

Life time : >50.000 ore

Sistema lenti FRAEN secondarie
FRAEN Secondary lens system



KHATOD NACTUS compatibile
Compatible KHATOD NACTUS

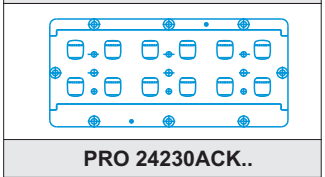

Codice Code	[W]	N° led Led N°	Fusso [lm] Flux [lm]	colore [k] color [k]	Irragg. Radiance	Lente Lens	Tensione [V] Voltage [V]	Peso[kg] Weight [kg]
PRO 48EX230AC	100	48	10400	5000	115°	-	230Vac	13,0
PRO 48EX230AC44	100	48	10400	5000	-	44°	230Vac	14,0
PRO 48EX230ACK..	100	48	10400	5000	-	KATHOD page Y5	230Vac	14,4
PRO 48EX24DC	100	48	10400	5000	115°	-	24Vdc	13,0
PRO 48EX24DC44	100	48	10400	5000	-	44°	24Vdc	14,0
PRO 48EX24DCK..	100	48	10400	5000	-	KATHOD page Y5	24Vdc	14,4

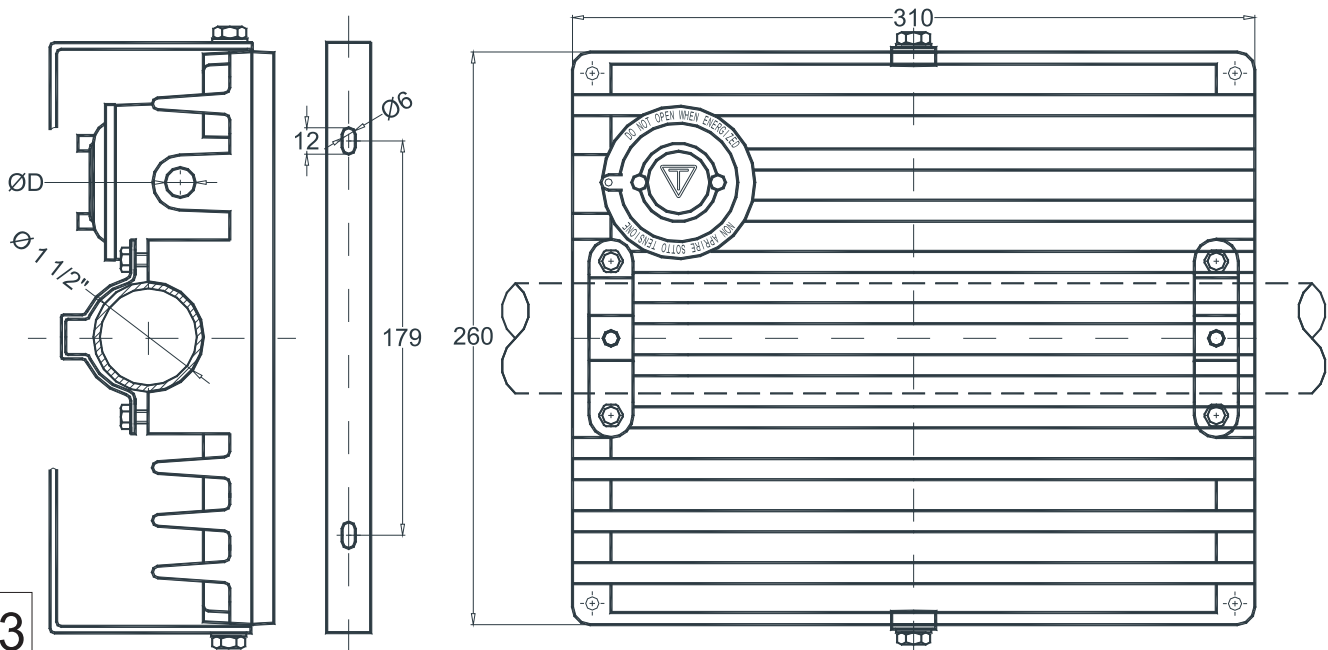







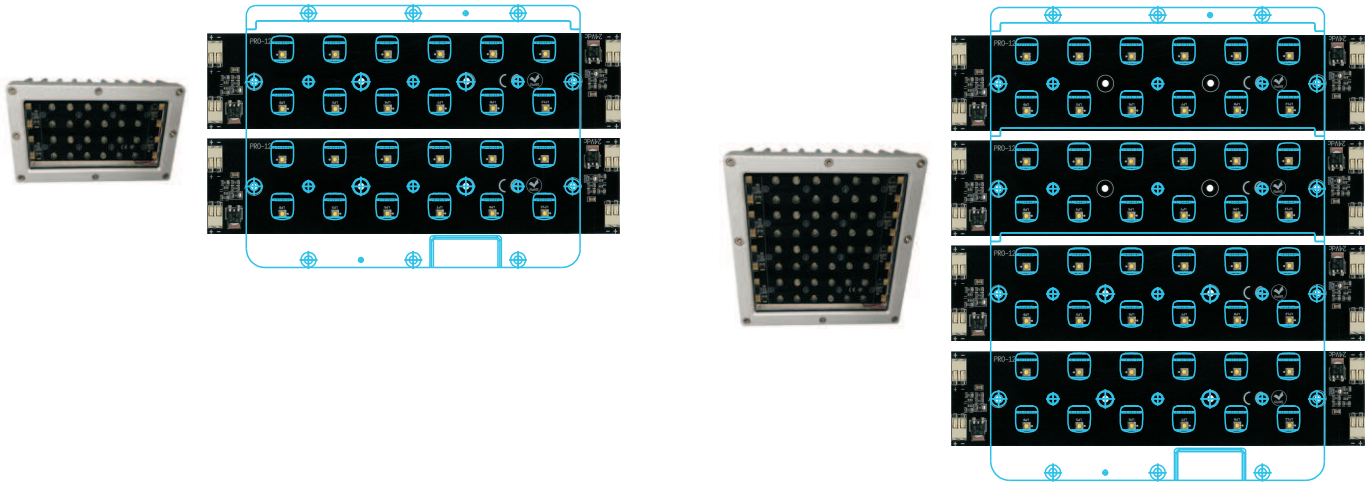

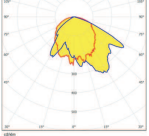
K3

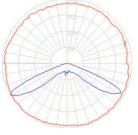

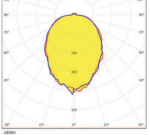
GAS	II2G Ex emb IIC T5 ÷ T4	Gb	IP66	Zone 1 - Zone 21 - Zone 2 - Zone 22
DUST	II2D Ex mb IIIC T95°C ÷ T130°C	Db	IP66	☀️ -20°C ÷ ☀️ +40°C ☀️ -20°C ÷ ☀️ +60°C

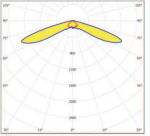
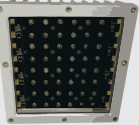

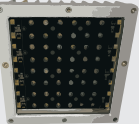
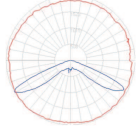
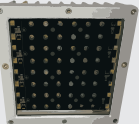
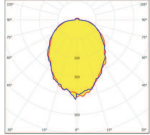
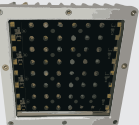
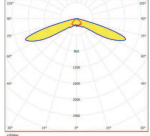
Codice Code	Descrizione Description	Altezza installazione Installation height	Tipo fascio Beam type	Ampiezza fascio Width beam	
KNAC2401 	MULTI LENS ARRAY 24 LED	4 meters	ASYMM	12 meters	
KNAC2404 	MULTI LENS ARRAY 24 LED	4 meters	120° SYMM	10 meters	
KNAC2410 	MULTI LENS ARRAY 24 LED	4 meters	90° SYMM	6 meters	
KNAC2409 	MULTI LENS ARRAY 24 LED	4 meters	60°x120°	12 meters	
KNAC4809 	MULTI LENS ARRAY 48 LED	6 meters	ASYMM	18 meters	
KNAC4802 	MULTI LENS ARRAY 48 LED	6 meters	120° SYMM	15 meters	
KNAC4808 	MULTI LENS ARRAY 48 LED	6 meters	90° SYMM	9 meters	
KNAC4807 	MULTI LENS ARRAY 48 LED	6 meters	60°x120°	18 meters	



Ex	GAS	II2G Ex emb IIC T4	Gb	IP66	Zone 1 - Zone 21 - Zone 2 - Zone 22		
	DUST	II2D Ex mb IIIC T130°C	Db	IP66	❄️-20°C ÷ ☀️+40°C	❄️-20°C ÷ ☀️+60°C	

Materiale : corpo : lega leggera
trasparente : vetro temperato con elevato rischio di impatto meccanico : 4 joule

Installazione : universale con staffa in acciaio inox AISI 304
Collare EVFP 34/1 per palina 1 1/2" a richiesta

Viteria : Acciaio inox AISI 304

Guarnizioni : Silicone - EPDM

Collegamento : Morsettiera 2.5mm²

Ingresso : N° 1 pressacavo M20x1.5

Material : *body : light alloy*
transparent : tempere high impact resistant
glass : 4 joule

Installation : *universal with stainless steel AISI 304 bracket*
Pole 1 1/2" lug code EVFP 34/1 on demand

Hardware : *Stainless steel AISI 304*

Gaskets : *Silicon - EPDM*

Connection : *Terminals 2.5mm²*

Cable entry : *N° 1 cable gland M20x1.5*

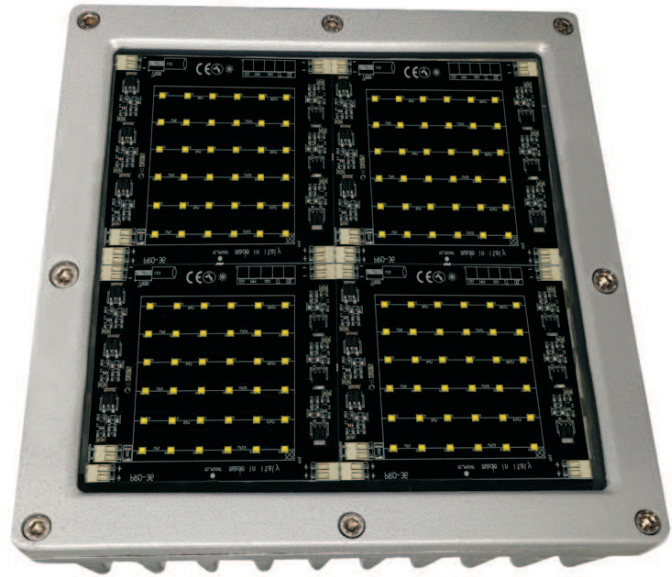

Potenza : Vedi tabella

Tensione : 230Vac (altre tensioni a richiesta)
24Vdc

Corrente : 2,3+9,2A

Frequenza : 50Hz + 60Hz

Indice colore : 80

Durata : >50.000 ore

Power : See table

Voltage : 230Vac (other voltage on demand)
24Vdc

Current : 2,3+9,2A

Frequency : 50Hz + 60Hz

Color index : 80

Life time : >50.000 ore

Sistema lenti FRAEN secondarie
FRAEN Secondary lens system



PRO 144..44

KHATOD IDEA compatibile
Compatible KHATOD EDEA

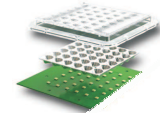

DISPONIBILE A BREVE / COMING SOON

Codice Code	[W]	N° led Led N°	Fusso [lm] Flux [lm]	colore [k] color [k]	Irragg. Radiance	Lente Lens	Tensione [V] Voltage [V]	Peso[kg] Weight [kg]
PRO 144EX230AC	240	144	24000	5000	115°	-	230Vac	13,0
PRO 144EX230AC10	240	144	23000	5000	15°	-	230Vac	14,0
PRO 144EX230AC60	240	144	23500	5000	60°	60°	230Vac	14,4
PRO 144EX24DC	240	144	24000	5000	115°	-	24Vdc	13,0
PRO 144EX24DC10	240	144	23000	5000	15°	.	24Vdc	14,0
PRO 144EX24DC160	240	144	23500	5000	60°	60°	24Vdc	14,4

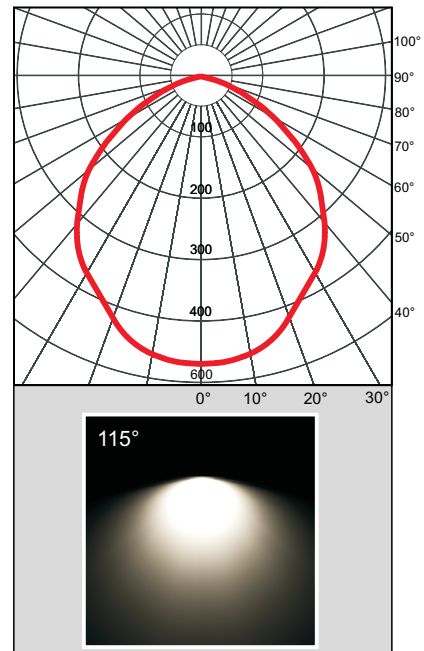
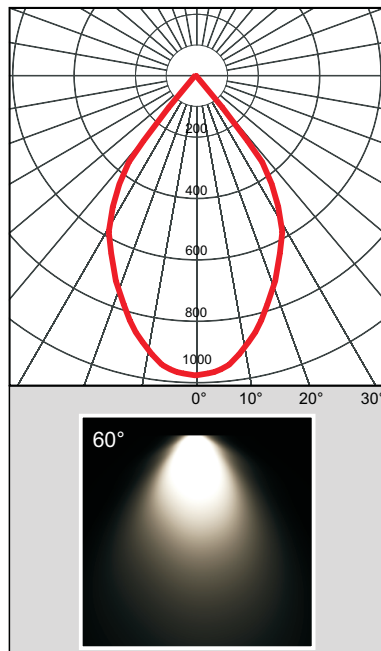
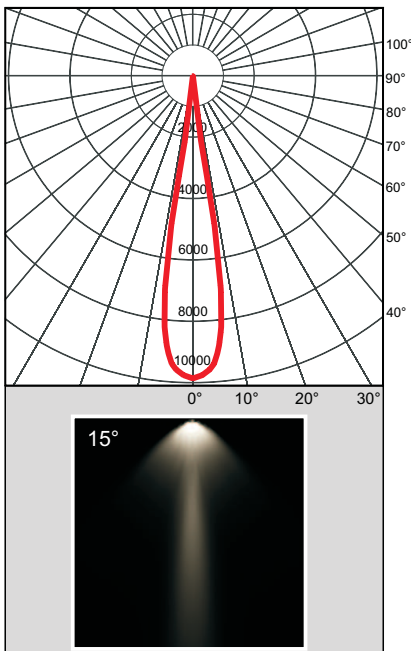

K5



GAS	II2G Ex emb IIC T5 ÷ T4	Gb	IP66	Zone 1 - Zone 21 - Zone 2 - Zone 22
DUST	II2D Ex mb IIIC T95°C ÷ T130°C	Db	IP66	❄️-20°C ÷ ☀️+40°C ❄️-20°C ÷ ☀️+60°C

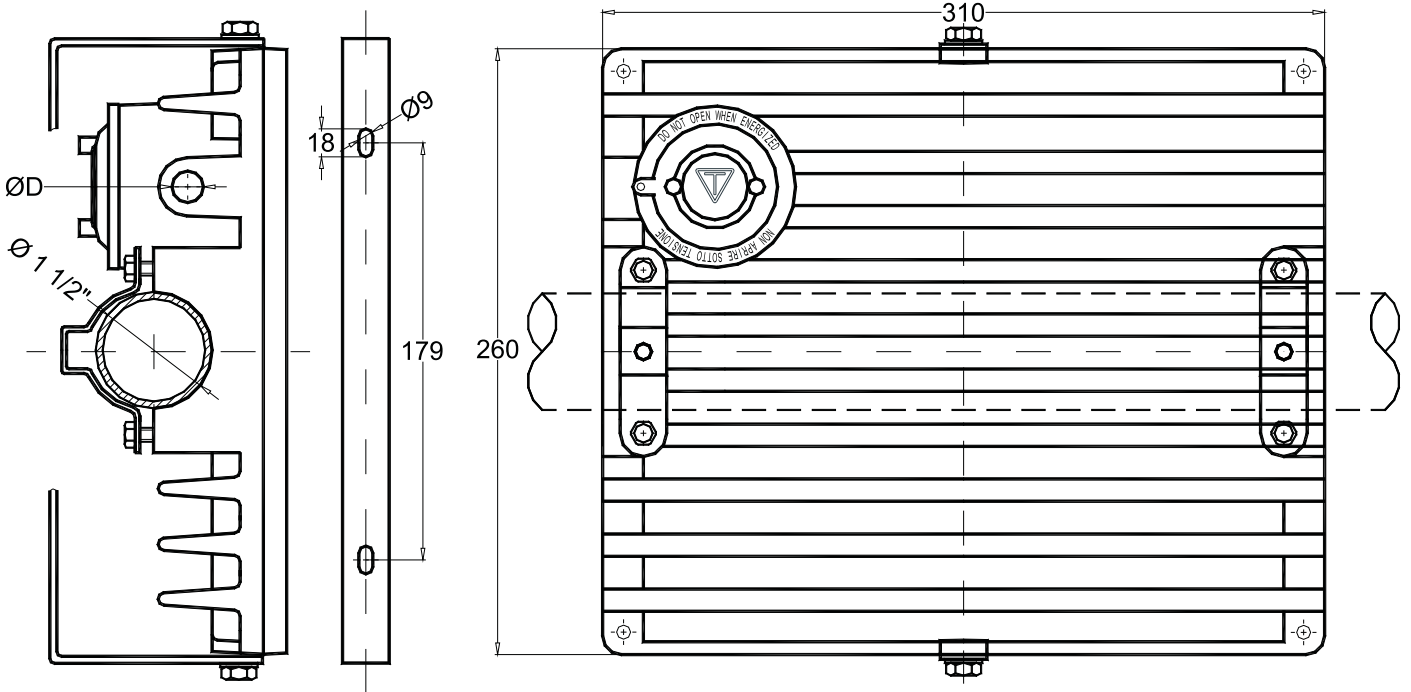



GAS	II2G Ex emb IIC T4	Gb	IP66	Zone 1 - Zone 21 - Zone 2 - Zone 22	
DUST	II2D Ex mb IIIC T130°C	Db	IP66	❄️-20°C ÷ ☀️+40°C	❄️-20°C ÷ ☀️+60°C

Materiale : corpo : lega leggera
trasparente : vetro temperato con elevato rischio di impatto meccanico : 4 joule

Installazione : universale con staffa in acciaio inox AISI 304
Collare EVFP 34/1 per palina d. 1 1/2" a richiesta
Acciaio inox AISI 304

Viteria : Acciaio inox AISI 304

Guarnizioni : Silicone

Collegamento : Morsettiera : 2.5mm²

Ingresso : N° 1 pressacavo ottone nichelato M20x1.5

Material : *body : light alloy
transparent : tempere high impact resistant
glass : 4 joule*

Installation : *universal with stainless steel AISI 304 bracket
Pole 1 1/2" lug code EVFP 34/1 on demand*

Hardware : *Stainless steel AISI 304*

Gaskets : *Silicon*

Connection : *Terminals mm² 2x1,5 mm²*

Cable entry : *N° 1 nickel plated cable gland M20x1.5*

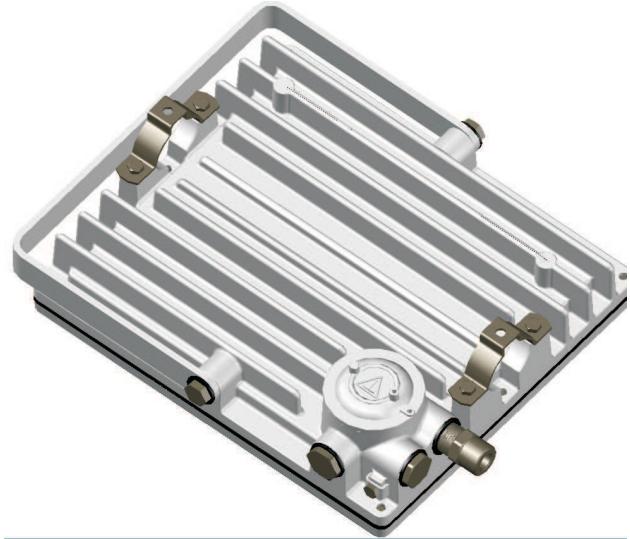

Potenza : Vedi tabella

Tensione : 230Vac senza alimentatore
poiche' compreso nell'unità LED

Corrente : 400mA - 500mA - 600mA

Frequenza : 50Hz + 60Hz

Indice colore : 80

Durata : >50.000 ore

Power : *See table*

Voltage : *230Vac without power supply device
because included in LED device*

Current : *400mA - 500mA - 600mA*

Frequency : *50Hz + 60Hz*

Color index : *80*

Life time : *>50.000 ore*

Codice Code	[W]	N° led Led N°	Fusso [lm] Flux [lm]	colore [k] color [k]	Irragg. Radiance	Lente Lens	Tensione [V] Voltage [V]	Peso[kg] Weight [kg]
PRO 48EX100230AC	100	100	11000	4000	120°	-	230Vac	13,0
PRO 48EX125230AC	125	125	13750	4000	120°	-	230Vac	13,0
PRO 48EX150230AC	150	150	16500	4000	120°	-	230Vac	13,0

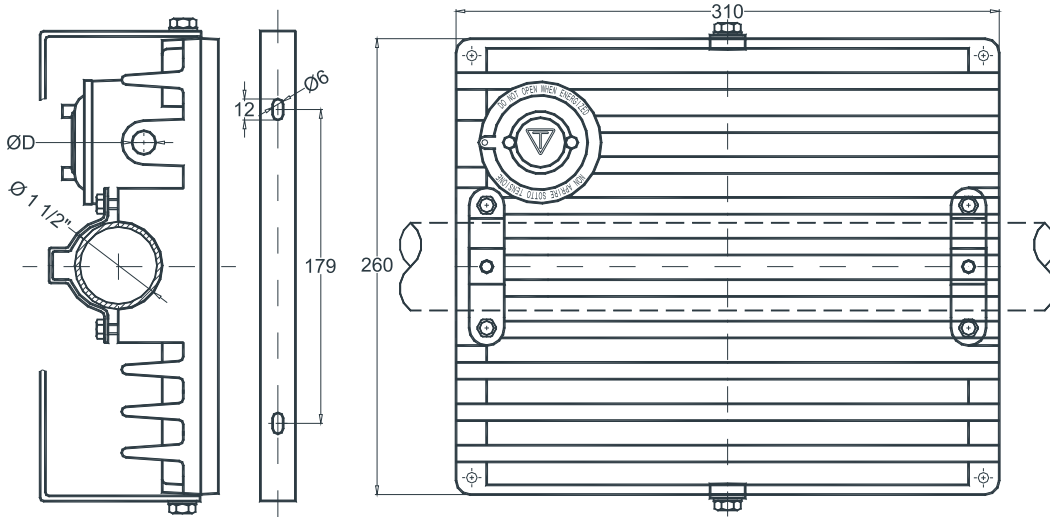

K7



Ex	GAS	II2G Ex emb IIC T6 ÷ T6	Gb	IP66	Zone 1 - Zone 21 - Zone 2 - Zone 22	
	DUST	II2D Ex mb IIIC T95°C ÷ T130°C	Db	IP66	❄️ -20°C ÷ ☀️ +40°C	❄️ -20°C ÷ ☀️ +60°C

Materiale : corpo : lega leggera
trasparente : vetro temperato con elevato rischio di impatto meccanico : 4 joule

Installazione : cavalletto in acciaio verniciato giallo

Viteria : Acciaio inox AISI 304

Guarnizioni : Silicone

Collegamento : Morsettiera : 2.5mm²
oppure cavo 2x1.5 H07RN-F 2x1,5 mm²

Ingresso : N° 1 pressacavo M20

Spina : II2G Exd IIC II2D Ex tb IIIC IP66 codice BP da utilizzare con presa FSQ non compresa

Material : body : light alloy
transparent : tempere high impact resistant
glass : 4 joule

Installation : universal with stainless steel AISI 304 bracket

Hardware : Stainless steel AISI 304

Gaskets : Silicon

Connection : Terminals mm²
or cable 2x1.5 H07RN-F 2x1,5 mm²

Cable entry : N° 1 cable gland M20

Plug : II2G Exd IIC II2D Ex tb IIIC IP66 code BP to use with socket FSQ not included



Potenza : Vedi tabella

Tensione : 24Vdc - 24Vac - 230Vac

Frequenza : 50Hz + 60Hz

Indice colore : 80

Durata : >50.000 ore

Power : See table

Voltage : 24Vdc - 24Vac - 230Vac

Frequency : 50Hz + 60Hz

Color index : 80

Life time : >50.000 ore

Codice Code	X [mm]	[W]	N° led Led N°	Fusso [lm] Flux [lm]	colore [k] color [k]	Irragg. Radiance	Irragg. Radiance	Tensione [V] Voltage [V]	Peso[kg] Weight [kg]
PRO 12EX230ACP	110	20	12	2000	5000	115°	-	230Vac	7,2
PRO 12EX230AC44P	110	20	12	2000	5000	-	44°	230Vac	7,2
PRO 12EX24DCP	110	20	12	2000	5000	115°	-	24Vdc	7,0
PRO 12EX24DC44P	110	20	12	2000	5000	-	44°	24Vdc	7,0
PRO 12EX24ACP	110	20	12	2000	5000	115°	-	24Vac	7,2
PRO 12EX24AC44P	110	20	12	2000	5000	-	44°	24Vac	7,2

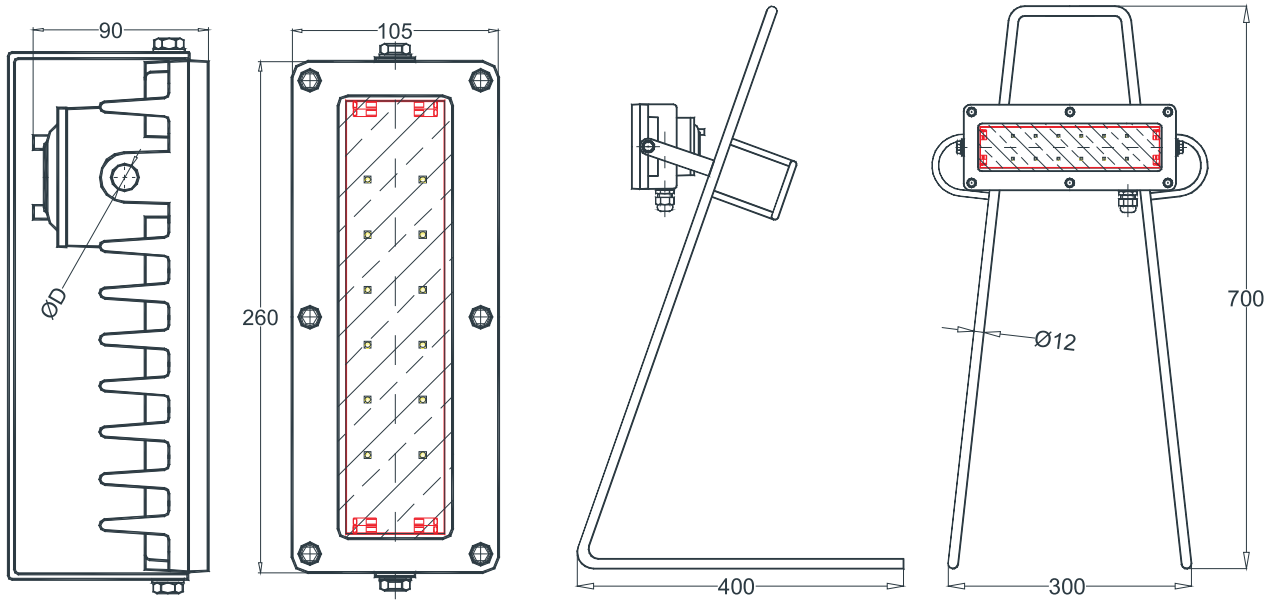

K8

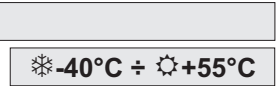
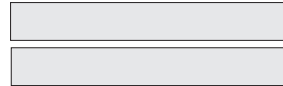
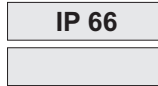
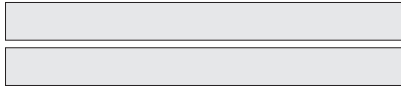
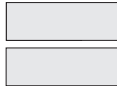

Materiale :	corpo : lega leggera trasparente : vetro temperato con elevato rischio di impatto meccanico : 4 joule
Installazione :	cavalletto in acciaio verniciato giallo
Viteria :	Acciaio inox AISI 304
Guarnizioni :	Silicone
Collegamento :	Morsettiera : 2.5mm ² oppure cavo 2x1.5 H07RN-F 2x1,5 mm ²
Ingresso :	N° 1 pressacavo M16x1.5
Spina :	in poliammide IP66 da utilizzare con presa CEE
Material :	body : light alloy aluminium transparent : tempere high impact resistant glass : 4 joule
Installation :	universal with stainless steel AISI 304 bracket
Hardware :	Stainless steel AISI 304
Gaskets :	Silicon
Connection :	Terminals mm ² or cable 2x1.5 H07RN-F 2x1,5 mm ²
Cable entry :	N° 1 cable gland M16x1.5
Plug :	polyammide plug IP66 to use with CEE socket



Potenza :	Vedi tabella
Tensione :	24Vdc - 24Vac - 230Vac
Corrente :	0,85+3,4A
Frequenza :	50Hz + 60Hz
Indice colore :	80
Durata :	>50.000 ore
Power :	See table
Voltage :	24Vdc - 24Vac - 230Vac
Corrente :	0,85+3,4A
Frequency :	50Hz + 60Hz
Color index :	80
Life time :	>50.000 ore

Codice Code	X [mm]	[W]	N° led Led N°	Fusso Flux [lm]	colore [k] color [k]	Irragg. Radiance	Irragg. Radiance	Tensione [V] Voltage [V]	Peso[kg] Weight [kg]
PRO 1224DC	110	20	12	2000	5000	115°	-	24Vdc	7,0
PRO 1224DC44	110	20	12	2000	5000	-	44°	24Vdc	7,2
PRO 1224AC	110	20	12	2000	5000	115°	-	24Vac	7,1
PRO 1224AC44	110	20	12	2000	5000	-	44°	24Vac	7,4

